

**OSR 140 Precast Concrete Stormceptor®  
(900 U.S. Gallon Capacity)**

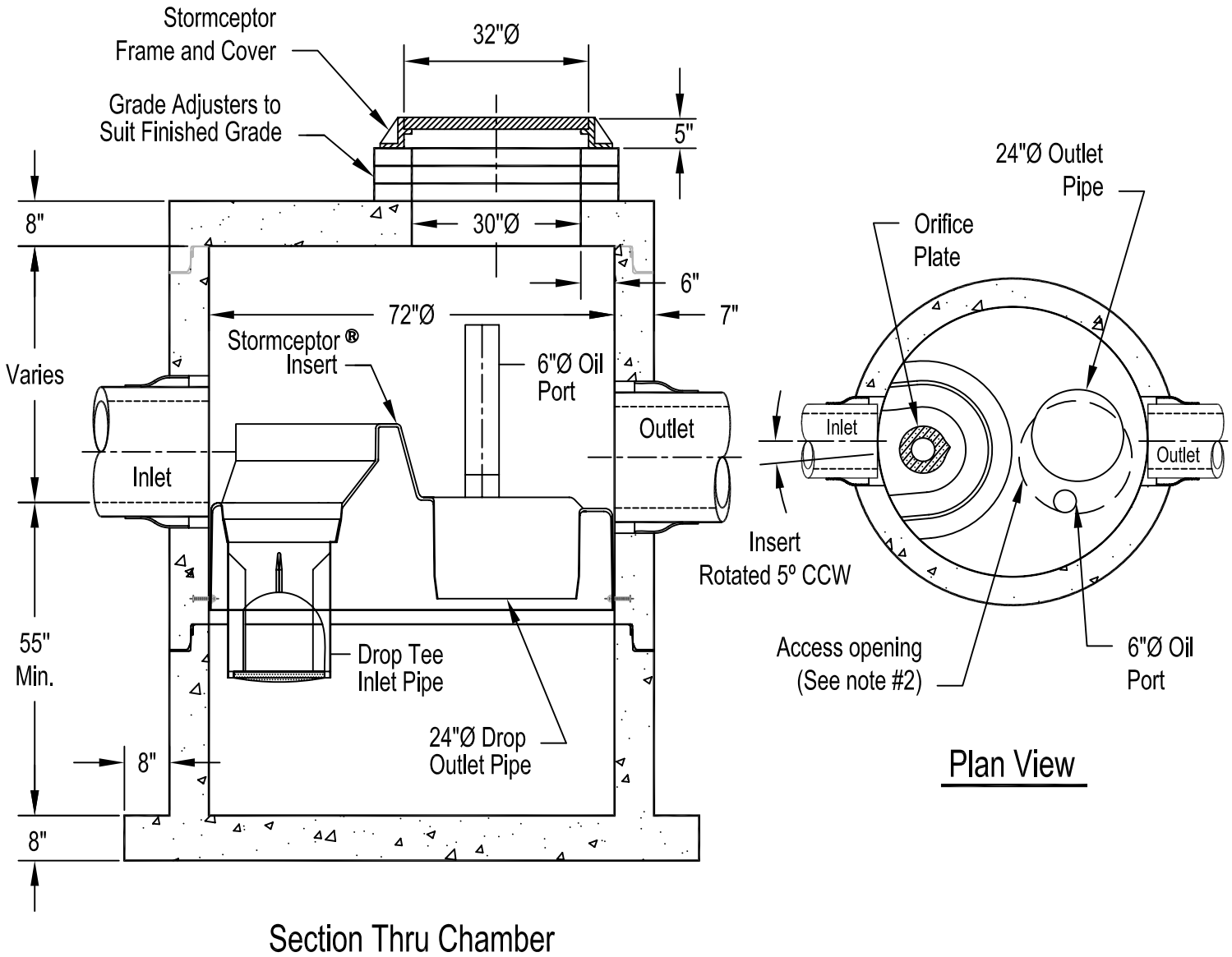

Notes:

1. The Use Of Flexible Connection is Recommended at The Inlet and Outlet Where Applicable.
2. The Cover Should be Positioned Over The Outlet Drop Pipe and The Oil Port.
3. The Stormceptor System is protected by one or more of the following U.S. Patents: #4985148, #5498331, #5725760, #5753115, #5849181, #6068765, #6371690, OSR Patent Pending.
4. Contact a Concrete Pipe Division representative for further details not listed on this drawing.